

# ***Brandt***

GUIDE TO INSTALLATION AND USE

## **Washing Machine**



# CONTENTS

Safety instructions.....	2
Installation.....	5
Operation .....	11
Maintenance .....	23
Troubleshooting .....	27
Availability of spare parts .....	29

## Safety instructions

- This appliance is designed to be used for domestic applications only
- The appliance must be connected to the mains water supply using the brand new connection fittings supplied with the appliance. Never reuse old fittings.
- Never obstruct the ventilation openings.
- This appliance can be used by children aged 8 years and over and by individuals with physical, sensory or reduced mental capacity, or lack of experience and knowledge under supervision or if they have been given instructions on how to use the appliance safely and have fully understood the risks involved. Children must not be allowed to play with the appliance. Cleaning and maintenance operations must not be carried out by children without supervision.
- Children under the age of three should be kept away from the appliance unless they are under constant supervision.
- If the power cord is damaged, it should be replaced by the manufacturer, its after-sales service department or a similarly qualified person, so as to avoid danger.
- Regarding the instructions for installing the appliance and making its electrical connections, please refer to the appropriate section in this guide.
- **WARNING:** Do not connect the appliance to hot water.
- The maximum weight of dry laundry is 9 kilograms.
- Maximum water supply pressure: 1 MPa
- Minimum water supply pressure: 0.05MPa

## ⚠ Warning!

### Product installation

- This washing machine is intended for indoor use only.
- It is not designed for built-in installation.
- Never obstruct the openings.
- This washing machine must not be installed in bathrooms, very damp rooms or in rooms where there

are explosive gasses or caustic substances.

- If the washing machine has only one water inlet valve, connect it to a cold water source only.
- The power plug must remain accessible after the appliance is installed.
- Remove all packaging materials and the transit bolts before using the appliance. Failure to do so may seriously damage your washing machine.

## **Appliance damage hazard!**

- Your appliance is for household (domestic) use only and is designed solely for machine washable textiles.
- Do not climb on the top of the washing machine.
- Do not lean against the door of the washing machine.

Care when handling the washing machine:

1. The transit bolts must be refitted to the washing machine by a qualified person.
2. Drain any water from the appliance before moving the washing machine.
3. Handle the appliance with care. Never lift the appliance by grabbing projecting parts. The door must not be used as a handle when moving the appliance.
4. This appliance is heavy. Carry it with care.
  - Do not close the door using excessive force. If the door is hard to close, make sure that the drum is not overloaded and that the laundry is properly distributed.
  - Do not wash carpets.

## **Operation of the appliance**

- Before using the appliance for the first time, perform a complete wash cycle empty.
- Use of inflammable and explosive solvents is prohibited. Never use fuel and alcohol, etc. as detergents. Only choose detergents that are suitable for machine washing.
- Empty the pockets of your clothes. Cutting and rigid objects like coins, pins, nails, screws, stones, etc. may seriously damage this appliance.

- Check that the water inside the drum has been drained before opening the door. Do not open the door if you can still see water inside the washing machine.
- Be careful to avoid injury when draining very hot washing water.
- Never add water by hand during washing.
- Once the washing cycle has finished, wait two minutes before opening the door.

# Installation

## Description of the product

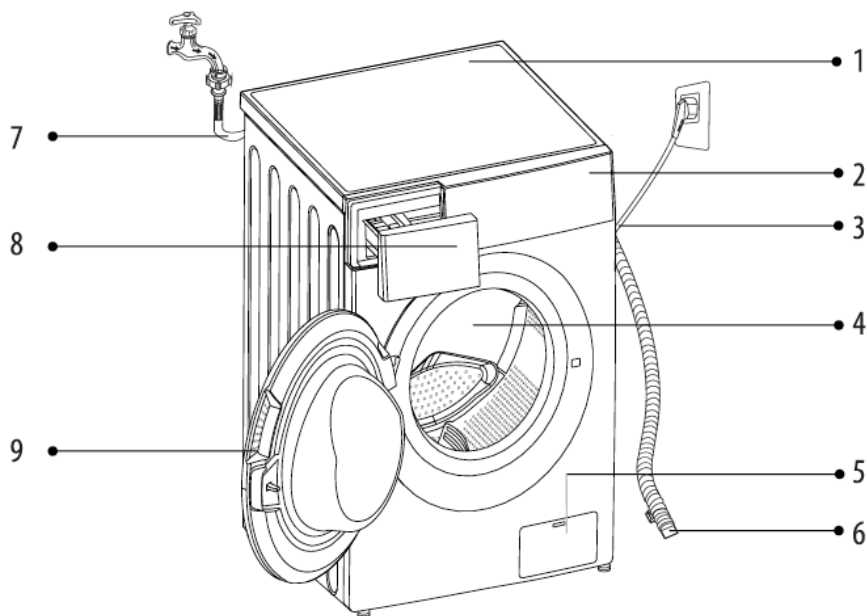





- |                  |                          |
|------------------|--------------------------|
| 1. Top panel     | 6. Drain hose            |
| 2. Control panel | 7. Water supply hose     |
| 3. Power cord    | 8. Detergent compartment |
| 4. Drum          | 9. Window                |
| 5. Filter        |                          |



### Note!

- The illustration of the accessories is provided for reference purposes only. Please refer to the actual product.

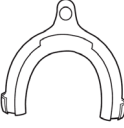
## Accessories

 <p>Transit bolt hole covers</p>	 <p>Cold water supply hose</p>	 <p>Drain hose (optional)</p>	 <p>Drain hose holder (optional)</p>	 <p>User guide</p>
---	---	--	---	---

EN

## Installation location

### **Warning!**

- It is important that the product be stabilised so that it will not move!
- Ensure that the appliance is not resting on the power cord.

To install your washing machine, choose a location that is:

1. On a hard, dry, flat surface
2. Not exposed to direct sunlight
3. Adequately ventilated
4. In a room at ambient temperature
5. Away from heat sources

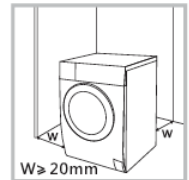

The washing machine is designed to operate at ambient temperature. If it is used in a room where the temperature is below 0°C, the water inlet valve and the drainage system may be damaged.

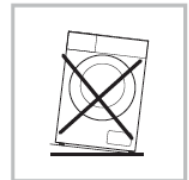

## Unpacking the washing machine

### **Warning!**

- Packaging materials (e.g. plastic film, polystyrene) can be hazardous to children.
- There is a suffocation hazard! Keep all packaging materials away from children.

1. Remove the cardboard box and the polystyrene wrapping.
2. Lift the washing machine and remove the packaging under it. Don't forget to remove the small foam triangle at the same time as the lower packaging. If you cannot do so, lay the washing machine on its side and remove the small foam triangle by hand.
3. Remove the adhesive tape that holds the power cord and the drain hose in place.
4. Remove the water supply hose from the drum.



## Remove the transit bolts

### **Warning!**

- You need to remove all of the transit bolts located at the back of the washing machine before using it.
- You'll need the transit bolts again if you move the washing machine. Keep them in a safe place.



Proceed as follows to remove the transit bolts:

1. Use a spanner to loosen the four transit bolts then pull them out.
2. Push the four transit bolt cover caps provided for this purpose into the holes.
3. Keep the transit bolts in a safe place for future reuse.

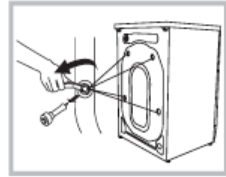

## Adjusting the levelling feet

### **Warning!**

- The lock nuts on the four levelling feet must be tightened against the washing machine body.

1. Check that the feet are still firmly attached to the washing machine. If this is not the case, return them to their original position and tighten the nuts.
2. Slacken the lock nut and turn the foot until it touches the floor.
3. Adjust the feet and lock them into position using a spanner. Check that the washing machine is stable.

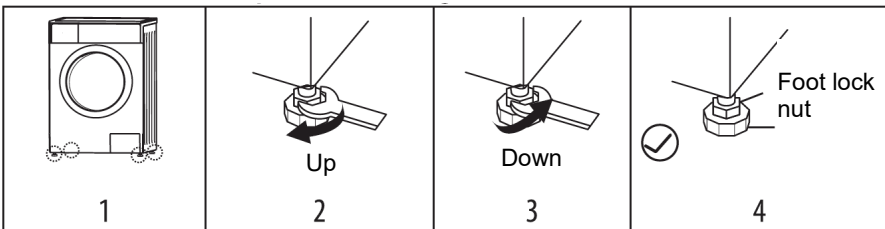

## Connecting the Water Supply Hose

### **Warning!**

- Follow the instructions in this section to avoid water leaks or water damage.
- Don't twist, squash, modify or cut the water supply hose.

Connecting the water supply hose to a threaded tap

EN

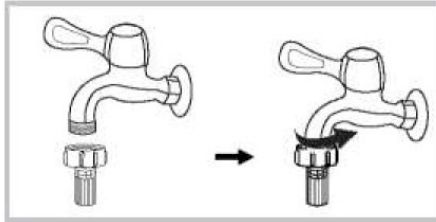

Threaded tap and water supply hose

Connect the other end of the water supply hose to the water supply valve located on the back of the washing machine then tighten down the hose by turning it clockwise.



## Drain hose



### Warning!

- Do not twist or extend the drain hose.
- Position the drain hose correctly. If you do not perform this operation correctly a water leak may occur.



### Note!

- If the washing machine is provided with a drain hose holder, install it as follows:

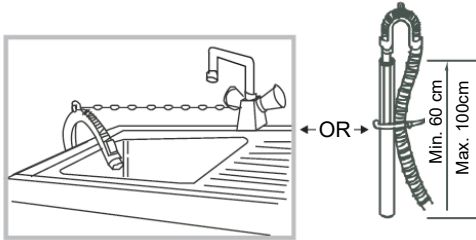

**⚠ Warning!**

- When you install a drain hose, attach it properly using a cord.
- If the drain hose is too long, never attempt to insert part of it into the washing machine by forcing it as this will cause unusual noises.

## Operation

EN

### Quick start

**⚠ Warning!**

- Before using your washing machine for the first time, always ensure that it is correctly installed.
- Before using your washing machine for the first time, perform a complete wash cycle empty.

### 1. Before washing

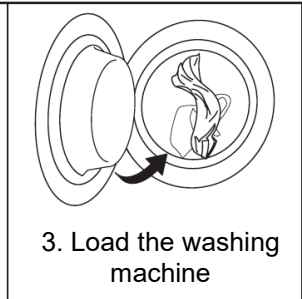
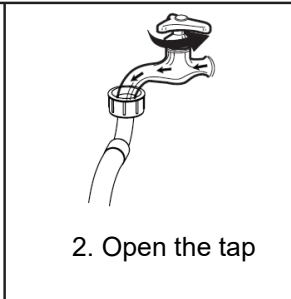
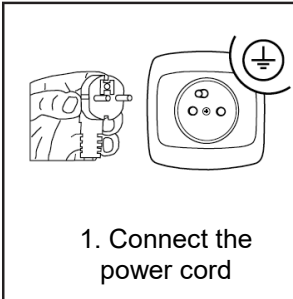

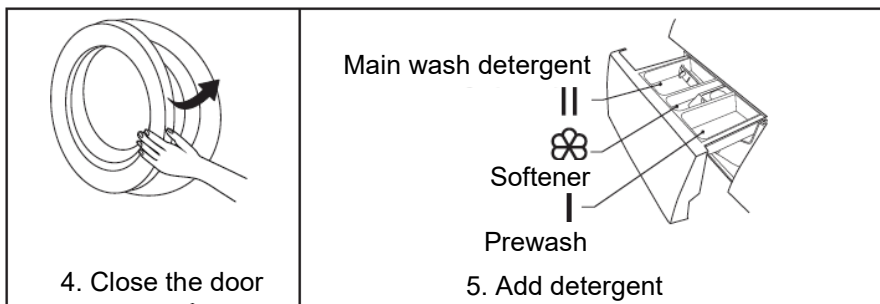

EN

## 2. Washing

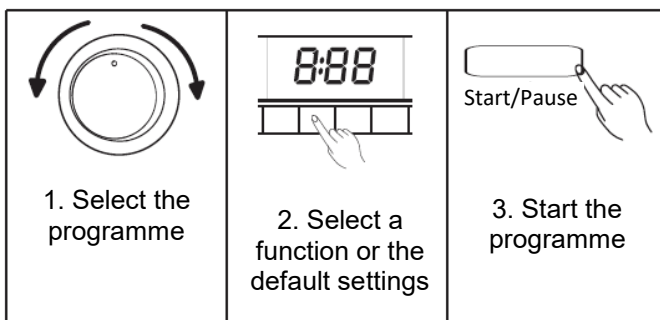

### Note!

- If you use the default settings, you can skip step 3.







## 3. After washing

An audible beep is heard or End is displayed on-screen.

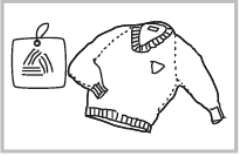
## Before every wash







- Always read the washing labels on garments and the explanations on how to use the detergent before washing. Choose detergent that produces little or no foam for optimum washing and to avoid any overflowing. Refer to the instructions provided by the detergent maker as shown on the detergent packaging.

EN

 <p>Always read the garment labels</p>	 <p>Empty the pockets of your clothes</p>	 <p>Attach long strings/ribbands, close zippers and button buttons</p>
 <p>Place small size clothes in pillowcases</p>	 <p>If clothes have raise fabric or suffer from piling, turn them inside out</p>	 <p>Sort clothes by texture</p>

## Choosing the correct detergent

A washing care label symbol shows the right choice of detergent, temperature and wash cycle.

Type of textile		Programme	Detergent
White cotton		Cotton temp. ≤ 90°C	Detergent with whitening product
Colours made of linen or cotton		Cotton temp. ≤ 60°C	Colours without whitening product
Mixed fibres		Mixed temp. ≤ 60°C	Colour wash
Synthetics		Synthetics temp. ≤ 60°C	Colour/delicate wash
Delicate textiles		Wool temp. ≤ 40°C	Detergent for delicate textiles
Wool		Wool temp. ≤ 40°C	Detergent for wool

## Warning!

- If there are not enough clothes in the washing machine this may unbalance the drum and cause the unbalance detection to trigger, significantly reducing the spin speed.
- Add a few clothes to remove the unbalance so that the washing machine can spin at the speed you have selected.

## Detergent compartment

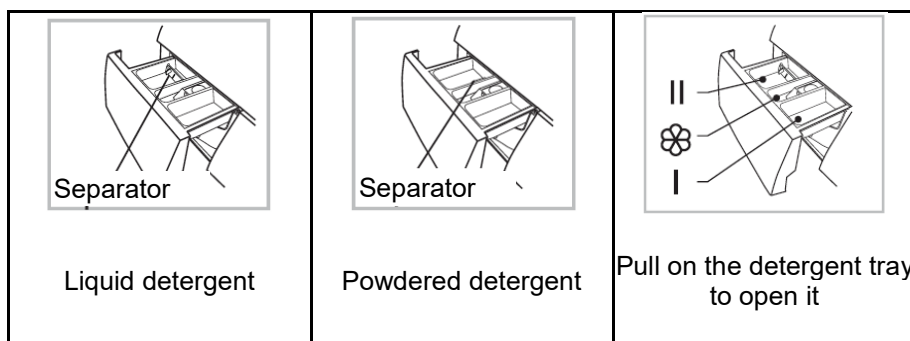

- I Prewash detergent  
 II Main wash detergent  
 Softener





## Warning!

- You only need to put detergent in compartment I if you selected the Prewash function on washing machines provided with this function.

Programme	I	II		Programme	I	II	
ECO 40-60		●	○	Sportswear	○	●	○
Cotton	○	●	○	Wool		●	○
Quick 15'		●	○	20°C		●	○
Rapid 45'	○	●	○	Mix	○	●	○
Intensive		●	○	Jeans	○	●	○
Rinse and Spin			○	Baby care	○	●	○
Spin only				Synthetics	○	●	○
Bed linen	○	●	○				

● Must Do

○ Optional

## Washing products

- Use washing products designed especially for washing machines:
  - Powdered detergents for all kinds of textiles except delicate ones. For these detergents, we recommend first diluting them with some water to avoid clogging the detergent pipe causing water to overflow when washing starts.
  - Liquid detergents for all low temperature programmes for all kinds of textiles or specialist liquid detergents (e.g. for woollens).
- Choose the detergent with care to match the required washing temperature, to optimise washing while saving water and energy. Excess dosages may cause poor rinsing and leave residual traces of detergent. On the other hand, an inadequate dosage may cause poor washing results.



# The control panel

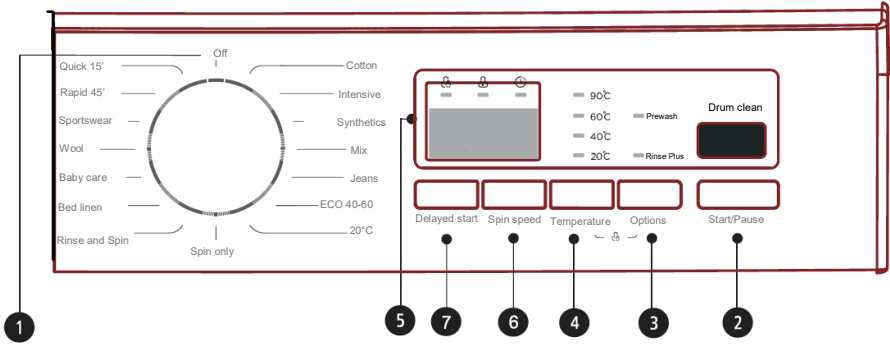

EN

## 1 Program dial

You can select the programme of your choice to match your washing requirements.

## 3 Options button

Successively press the button to select the Prewash or Rinse Plus options.

## 5 Display

The display shows the settings, the time remaining and information on washing in progress. It remains lit for the entire cycle.

## 7 Delayed start/Pause button

This button is used to delay starting a washing cycle. Press and hold the button until the desired time is displayed (up to 24 hours).

## 2 Start/Pause button

Press to start the selected wash cycle. Press during the cycle to pause it.

## 4 Temperature button

Press this button to choose the desired temperature: the light that matches your choice will come on. If no light is on, then the water is at ambient temperature.

## 6 Spin speed button

Choose the spin speed for the selected washing programme.

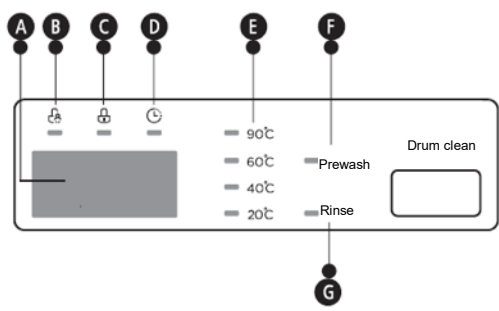

## A Display

Wash time	1:25	Delayed start	2 hours
Spin speed	100	Error	E30
End	End		

## B Child safety      C Door lock

## D Delayed start      E Temperature

## F Prewash      G Rinse Plus



## Warning!

- To change a setting after starting the washing cycle, turn the mode selector to the OFF position. Select the programme, the spin speed and the options again, then press the **Start / Pause** button.  
(Ensure that the child safety function is disabled or the initially selected programme will continue to run.) Just before leaving the factory, the appliance is subject to a last check when water is poured into the drum.
- Consequently, there may be water drops or condensation inside the washing machine. This is not an indication of a malfunction.



## Note!

- When the appliance is started and used for the first time. There may be a slight smell when the motor runs for the first time.

## Options

Prewash

### Prewash

The Prewash option lets you perform an additional wash before the main wash. This is a suitable option for eliminating dirt from your laundry. You will need to place detergent in compartment (1) after choosing this option.

Rinse Plus

### Rinse Plus

When this option is selected, your laundry will get an extra rinse.

Delayed start

### Delayed start

Setting the delayed start function:

1. Choose the time by pressing the Delayed start function (you can select a delay from 0 to 24 hours).
2. Press the Start/Pause button to start the Delayed start function.



Setting the time

Start/Pause

labelling the delayed start function:

Press the Delayed start button until 0H is displayed. This operation cannot be performed once the washing cycle is started. If the program has already started, place the selector in the Off position to reset it.

Programme	Options			Programme	Options		
	Delayed start	Rinse Plus	Prewash		Delayed start	Rinse Plus	Prewash
ECO 40-60	<input type="radio"/>			Sportswear	<input type="radio"/>	<input type="radio"/>	<input type="radio"/>
Cotton	<input type="radio"/>	<input type="radio"/>	<input type="radio"/>	Wool	<input type="radio"/>	<input type="radio"/>	
Quick 15'	<input type="radio"/>			20°C	<input type="radio"/>	<input type="radio"/>	
Rapid 45'	<input type="radio"/>	<input type="radio"/>	<input type="radio"/>	Mix	<input type="radio"/>	<input type="radio"/>	<input type="radio"/>
Intensive	<input type="radio"/>	<input type="radio"/>		Jeans	<input type="radio"/>	<input type="radio"/>	<input type="radio"/>
Rinse and Spin	<input type="radio"/>	<input type="radio"/>		Baby care	<input type="radio"/>	<input type="radio"/>	<input type="radio"/>
Spin only	<input type="radio"/>			Synthetics	<input type="radio"/>	<input type="radio"/>	<input type="radio"/>
Bed linen	<input type="radio"/>	<input type="radio"/>	<input type="radio"/>				

Optional

## Other options



### Temperature

Press the Temperature button until the desired temperature is obtained. (Cold, 20°C, 30°C, 40°C, 60°C, 90°C).



### Spin speed

Press the spin speed button until the desired spin speed is displayed.  
0-400-600-800-1000-1200 1400



### Drum clean

After 25 washing cycles, the Drum clean light comes on showing that cleaning is recommended.

This special programme is used to disinfect the machine at a temperature of 90°C. Press the button to start the programme.

Once the drum clean has been run, a new 25-cycle count starts.

If you do not wish to run a drum clean cycle, press the Drum clean button for three seconds. The light will go out and you can start a normal wash cycle.



## Note!

- This program is run with the machine empty. Do not place any laundry in the machine during this cycle. We recommend using this programme to improve hygiene and to extend the life of your washing machine.



## Warning!

- If a power break occurs when the washing machine is running, the internal memory saves the selected program. Once the power has returned, press the **Start/Pause** button to resume the programme.



## Child safety lock

This function is used to lock the buttons so that the current program cannot be changed especially when a child plays with the keys.

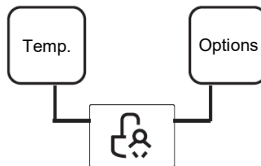

Press Temperature and Options at the same time for three seconds, until a beep is heard.



## Warning!

- To disable the Child safety lock, press the same two buttons for three seconds.
- The Child safety lock function will lock all of the buttons except for the selector.
- When you switch the appliance off, the Child safety lock is disabled.
- The Child safety function remains active when the washing machine restarts after a power break.



## Switching off the audible beep

Press the  button for three seconds to switch off the audible beep

Perform the same action to restart it.

The last setting will be retained until the next reset.



## Warning!

- After switching off the audible beep, the appliance no longer makes any sound.

# Programmes

The programmes are adapted to the kind of laundry.

Programmes	
Cotton	This programme is suited to a load consisting of resistant white or coloured cotton.
Synthetics	This programme is ideal for a load consisting of resistant synthetics.
Baby care	This program improves rinse performance to remove as much detergent residue as possible. This serves to better protect a baby's skin.
Rapid 45'	This programme is used to quickly wash a small load of laundry that is not very dirty.
Mix	This programme is ideal for a load consisting of mixed fibres.
20°C	This low temperature washing programme is recommended for washing and protecting colours.
Jeans	This programme is specially intended for washing jeans. It reduces colour washout and its more intensive rinse avoids any residual traces of detergent.
Quick 15'	This programme is used to very quickly wash a small load of laundry that is not very dirty.
Intensive	This programme is intended for dirty laundry, increasing the drum rotation rate and cycle time.
Wool	This programme is specially intended for protecting your woollens. Thanks to longer soaking periods, your woollens will be washed gently.
Spin only	This programme is used to only spin your clothes by choosing the desired spin speed.
Rinse and Spin	This programme is used to simply rinse and spin your clothes.
ECO 40-60	This programme is used to wash your laundry at 40°C (a temperature that cannot be changed), while optimising water and power consumption.
Sportswear	This washing programme is used to preserve the elastic fibres in sportswear so that they do not stretch and they retain their technical properties.
Bed linen	This programme is specially intended for washing bedding. This intensive cycle ensure in-depth washing and additional rinsing.

## Washing programme table

### WFB190WA

Cycle	Rated capacity in kg	Cycle duration in hours:minutes	Power consumption in kWh	Water consumption in litres	Temperature in °C	Remaining moisture content	Spin speed
Cotton	9.0	2:40	1.15	75	40	60.0%	1200
Synthetics	4.5	2:20	0.7	60	40	35.0%	1200
Baby care	9.0	1:43	1.5	70	60	70.0%	800
Jeans	9.0	1:45	1.5	70	60	70.0%	800
Mix	9.0	1:20	0.9	70	40	70.0%	1200
20 °C	4.5	1:01	0.25	60	20	65.0%	600
Rinse and Spin	9.0	0:20	0.065	25	15	60.0%	800
Spin only	9.0	0:12	0.055	-	-	60.0%	800
Intensive	9.0	3:48	1.2	70	40	70.0%	800
ECO 40-60	9.0	3:48	1.295	64	39	53.0%	1200
	4.5	2:54	0.848	50	35	53.0%	1200
	2.5	2:54	0.51	38	24	53.0%	1200
Bed linen	9.0	1:48	1	70	40	70.0%	800
Wool	2.0	1:07	0.5	55	40	80.0%	600
Sportswear	4.0	0:45	0.25	50	20	65.0%	800
Rapid 45'	2.0	0:45	0.75	40	40	70.0%	800
Quick 15'	2.0	0:15	0.05	40	15	75.0%	800

The EU energy efficiency classification is: E.

Energy efficiency test programme: ECO 40-60.

Speed: the highest; other settings are set to their default values.

Half-load for a washing machine with a capacity of 9.0kg: 4.5kg.

ECO 40-60 is the recommended program designed to minimize water consumption for normally soiled load at rated capacity.

The ECO 40-60 program is suitable for washing cotton items that are normally dirty and suitable for washing in the same cycle at 40°C or 60°C. This is the programme used to assess compliance with the European Union's eco-design regulations.

For WELS (Water Efficiency Labeling Scheme) Singapore, ECO 40-60 is the recommended program for normally soiled load equal to the rated capacity.



### Note!

- The values provided for programmes other than the ECO 40-60 program are provided as an indication only.

## Maintenance

### Cleaning and Care

#### **Warning!**

- Always switch off the appliance and turn off the water tap before any maintenance operations.

EN

### Cleaning the exterior of your washing machine

Suitable maintenance will optimise the service life of your washing machine. Appliance surfaces can be cleaned with neutral non-abrasive detergents diluted where necessary. If the water overflows, wipe it up immediately. Never use sharp objects.



#### **Note!**

- Do not use formic acid and its diluted solvents or equivalents such as alcohol, solvents or chemicals, etc.

### Cleaning the drum

Any rust left inside the drum by metal articles must be removed immediately with chlorine-free detergent. Never use steel wool.



**Note!**

- Do not put laundry in the washing machine during the drum cleaning.

### Cleaning the door and window seal

Wipe the window and seal after each wash to remove lint and stains. If lint builds up, it can cause leaks.

Remove coins, buttons and other objects trapped in the seal after every wash.

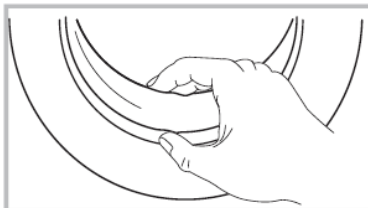

### Cleaning the water supply hose filter

**Note!**

- If there is hardly any water in the appliance and the tap is open, then the water supply hose filter needs to be cleaned.

1. Close the tap
2. Remove the Water Inlet Hose from the tap.
3. Clean the filter.
4. Reconnect the water inlet hose.

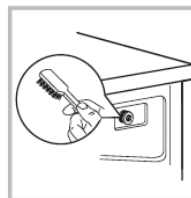
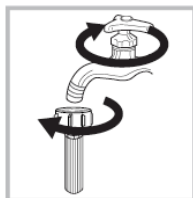

## Cleaning the washing machine filter

1. Unscrew the water inlet hose from the back of the machine.
2. Remove the filter using a pair of pliers.
3. Use a brush to clean the filter.
4. Refit the filter once cleaning is finished.
5. Reconnect the water inlet hose.

## Cleaning the detergent compartment

If you observe any dirtying of the detergent drawer, clean it.  
To do this:

1. Press down on the clip inside the detergent drawer as shown by the arrow.
2. Release the drawer and remove it so that you can wash it out with water.
3. Clip the drawer back into place and close it.

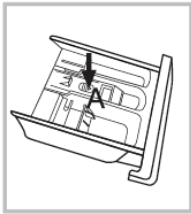

1. Open the detergent drawer by pressing on  
A

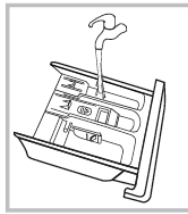

2. Clean the detergent drawer under running water

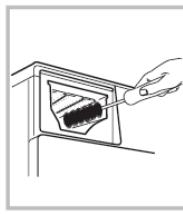

3. Clean the inside of the compartment where the detergent drawer fits, using an old toothbrush, for example.

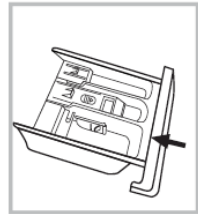

4. Refit the detergent drawer



### Note!

- Do not use alcohol, solvents or chemicals to clean the washing machine.

## Cleaning the drain pump filter

### **Warning!**

- Beware of hot water!
- Disconnect the appliance to avoid any electric shock hazard.
- The drain pump filter filters out lint and other small debris present in the laundry.
- Clean the filter regularly to ensure proper washing machine operation.

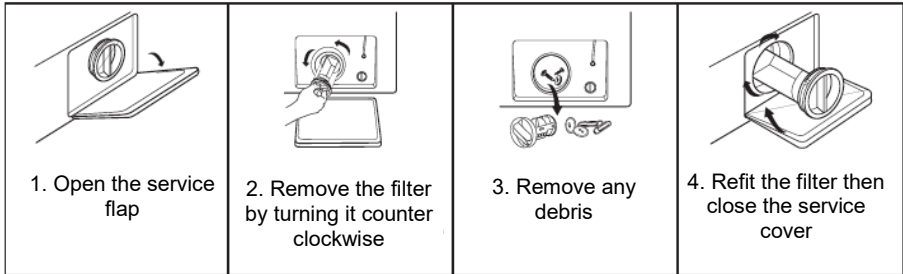

### **Warning!**

- Ensure that the filter is properly refitted to avoid any leakage.
- When the washing machine is running, never remove the filter. This operation must only be performed with the washing machine switched off.

## Preventing scale build-up

If you live in an area with hard water, we recommend using a washing machine descaling product. Regularly check for any scale build-up in the drum. If necessary, run an empty drum washing cycle with a descaling product. Refer to the instructions provided by on the product packaging.

## Troubleshooting

The washing machine cannot start up or stops during operation.

First attempt to solve the problem. If you cannot, then contact the service centre.

Description	Cause	Solution
Washing machine cannot start up	The door is not properly closed	Switch the washing machine back on after closing the door Check whether any clothes are trapped
Door cannot be opened	Washing machine's safety protection system is working	Disconnect the power, reconnect it and switch the machine back on
Water leakage	The connection between the washing machine and the water supply hose or the drain hose is not tight	Check the water pipes and tighten the connections Clean the drain hose
Detergent residues in the detergent compartment	The detergent is dampened and agglomerated	Clean and dry the compartment
Washing machine lights or display do not light up	The appliance is not switched on. Circuit problem. Connection problem.	Check that the power is on and that the power cord is properly connected.
Unusual noise		Make sure that the transit bolts have been removed Make sure that the washing machine is installed on a solid and level floor

Description	Cause	Solution
E30	The door is not properly closed	Close the door properly and restart the washing machine Check whether any clothes are trapped
E10	Problem adding water during washing	Check whether the water pressure is too low Straighten the water supply hose Check the water supply filter is not blocked
E21	Water drainage takes too long	Check if the drain hose is blocked
E12	Water leakage	Run another programme If error code E12 is still displayed, turn off the water supply, disconnect the washing machine and call your after sales service
EXX	Others	Do not hesitate to reset the washing machine contact our after sales service if the issues remain



### Note!

- Once this check is complete, start the washing machine. If the problem occurs again or if the error codes are displayed again, contact your after sales service.
- Any attempt made by the user or a non-professional to repair the appliance may affect user safety and void the appliance warranty.

## Performing your own repairs

Some repairs may be carried out by the user in certain cases. The [sav.groupebrandt.com](http://sav.groupebrandt.com) website offers you the option of ordering certain spare parts as well as bringing you access to technical data and safety instructions to guide you through troubleshooting. In line with the stipulations of Article L441-5 of the French Consumer Code (Code de la Consommation), the manufacturer cannot be held liable for any damage that occurs while performing your own repairs inasmuch as this damage is linked to improper procedures by the user or any failure by the latter to follow the instructions for repairing the product.

EN

## Availability of spare parts

The minimum length of time for making available spare parts listed in European Regulation 2019-2023-EU and accessible especially to the appliance user is 14 years under the terms set out in the above regulation.

## Technical specifications

Power supply	220-240V~/50Hz
Maximum current	10 A
Standard water pressure	0.05 MPa-1 MPa

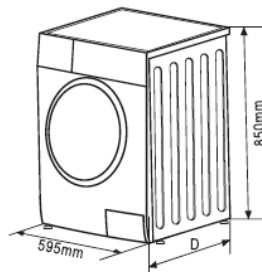

Model	Washing capacity	Dimensions (W x D x H mm)	Net weight	Rated power
WFB190WA	9.0kg	595*565*850	71kg	2000W

## General information on regulation EU 2019-2023

- When using the test programmes, wash the specified load using the maximum spin speed.
- The actual parameters will depend on how the appliance is used and may differ from the preset parameters.
- This domestic washing machine is equipped with a system for managing energy consumption. The time spent in the mode left to run is less than one minute.
- The most effective programs from a power and water consumption point of view are generally those that run at low temperature for a longer duration.
- Loading the domestic washing machine to the maximum capacity stated by the manufacturer for each programme contributes to saving power and water.
- The noise and remaining moisture content are influenced by the spin speed: the higher the spin speed during the spin phase, the higher the noise level and the lower the remaining moisture content of the laundry.
- To access the data on your model, stored in the product database in line with regulation (EU) 2019/2014 and data relating to energy labelling, please connect to the dedicated website at <https://eprel.ec.europa.eu/>  
Find the reference of your appliance on the website by entering the service reference shown on the ID plate on your appliance. Another way to access this information is to flash the QR code found on the energy label on your product.



Any repairs to your appliance must be made by a qualified professional accredited to work on the brand. When calling, please provide the full references of your appliance (commercial reference, service reference, serial number), so that we can handle your call more efficiently. This information can be found on the data plate.





This symbol on the product or in the instructions means that your electrical and electronic equipment should be disposed at the end of its life separately from your household waste. There are separate collection systems for recycling in the European Union.



For more information, please contact the local authority or your retailer where you purchased the product.