

FR

EN

ES

DE

EA

CS

NL

PL

IT

SK

DA

FI

NO

PT

SV

Brandt



INSTRUCTION MANUAL EN

Cooking Hob

Dear Customer,

You have just acquired a **BRANDT** product and we would like to thank you.

We have designed and made this product with you, your lifestyle and your requirements in mind so that it meets your expectations. We have devoted our know-how, our innovative spirit and the passion that has been guiding us for over 60 years.

In an effort to ensure that our products meet your requirements in the best possible way, our Customer Relations department is at your disposal, to answer all your questions and to listen to all your suggestions.









Visit our website www.brandt.com where you will find our latest innovations, as well as useful and complementary information.

BRANDT is delighted to assist you every day and hopes you get the most out of your purchase.



Important :

Before using your appliance, read this user guide carefully to familiarise yourself more quickly with its operation.

	SAFETY INSTRUCTION	4
	ENVIRONMENT AND ENERGY SAVING	6
	IDENTIFICATION	7
	INSTALLATION	9
	Unpacking	9
	Fitting	9
	Electrical connection	11
	USE.....	12
	Selecting the vessel	12
	Selecting the hotplate	12
	Ⓜ Switching on / off	13
	+ / - Power setting	13
	🕒 Setting the timer	14
	👨‍🍳 Boil function.....	14
	🔒 Child	14
	Safety and recommendations	15
	MAINTENANCE.....	16
	SPECIAL MESSAGES, INCIDENTS.....	17
	ENERGY EFFICIENCY.....	18
	AFTER SALES SERVICE	19



IMPORTANT SAFETY INSTRUCTIONS TO BE READ CAREFULLY AND KEPT FOR FUTURE USE.

This guide can be downloaded from the brand web site.

This appliance can be used by children over 8 years old and persons with reduced physical, sensory or mental capabilities or without experience and knowledge if they have been correctly informed or trained in the use of the appliance in a safe way and understand the hazards involved.

Children must not play with the appliance.

Children must not clean and maintain the appliance without supervision.

Children under 8 years old must be kept away from the hob unless they are supervised at all times.

The appliance and its accessible parts become hot during use.

Precautions must be taken to avoid touching the heating elements.

Metal objects such as knives, forks, spoons and lids must not be placed on the cooking surface as they may heat up.

Your hob is equipped with a child safety device that locks its operation after use or during cooking (See "Child Safety use" section).

Your appliance complies with applicable European Directives and regulations.

In order to avoid interference between your cooking hob and a pacemaker, the pacemaker must be designed and programmed in compliance with the regulations that apply to it. Ask the pacemaker manufacturer or your GP.

Leaving oil or fat to heat unattended on a hob may be dangerous and lead to fire. NEVER attempt to extinguish a fire with water. Instead, switch off the appliance, then cover the flame with a lid or a fire blanket.

CAUTION: cooking must be monitored. Quick heating must be monitored at all times.

Danger of fire: do not store objects on the cooking areas.

If the surface is cracked, disconnect the appliance to avoid the risk of electric shock.

Do not use your hob until you have replaced the glass worktop. Avoid hard shocks from cookware: although the vitroc ceramic glass worktop is very sturdy, it is not unbreakable.



Do not place any hot lids flat on your cooking hob. A suction effect may damage the vitroceramic surface. Avoid dragging cookware across the surface, which may in the long-term result in the degradation of the decorative finish of the vitroceramic top. Never use a sheet of aluminium for cooking. Never place items wrapped in aluminium foil or packaged in aluminium dishes on your cooking hob. The aluminium will melt and permanently damage your appliance.

Do not store cleaning products or flammable products in the cabinet underneath your cooking hob.

These hobs must be connected to the power grid via an all-pole cut-off device that complies with installation regulations in effect. A disconnection device must be incorporated into the fixed wiring.

If the power cable is damaged, it should be replaced by the manufacturer, its after-sales service department or a similarly qualified person to avoid danger. Ensure that the power cables of any electrical appliances plugged in close to the hob are not in contact with the cooking zones.

Never use a steam cleaner to

clean your cooking hob.

The appliance is not designed to be switched on using an external timer or a separate remote control system.

WARNING: Only use hob protectors designed by the manufacturer of the cooking appliance or listed as suitable in the user guide, or included with the appliance. Use of unsuitable protectors could cause accidents.

**Protecting the environment**

This symbol indicates that this product should not be treated as household waste.

Your appliance also contains a great amount of recyclable material. It is marked with this symbol to indicate that used appliances must be disposed of in certified collection points.

Contact your town hall or your retailer for the used appliance collection points closest to your home. This way, the appliance recycling organised by your manufacturer will be done under the best possible conditions, in compliance with European Directive on Waste Electrical and Electronic Equipment.

This appliance's packing materials are also recyclable. Help recycle it and protect the environment by dropping it off in the municipal receptacles provided for this purpose.

We thank you for your help in protecting the environment.

Advice on how to save energy

Cooking with the correctly sized lid saves energy. If you use a glass lid, you can control your cooking perfectly.



IDENTIFICATION

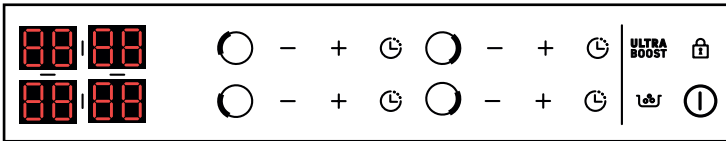
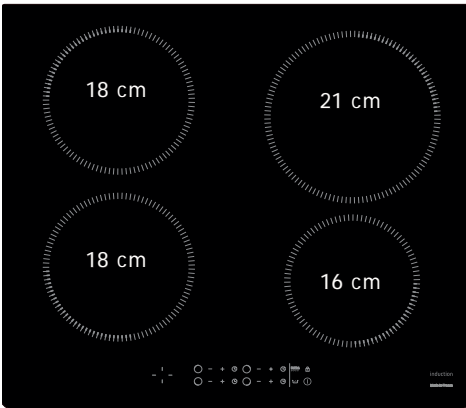
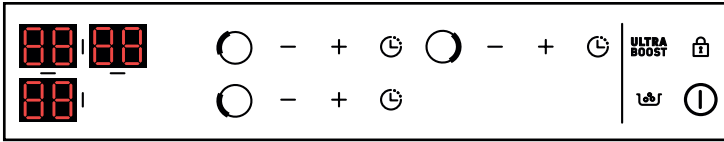
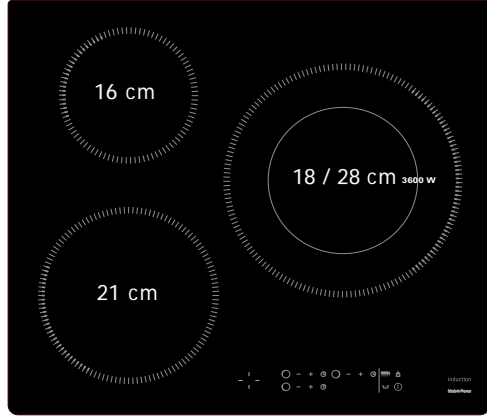
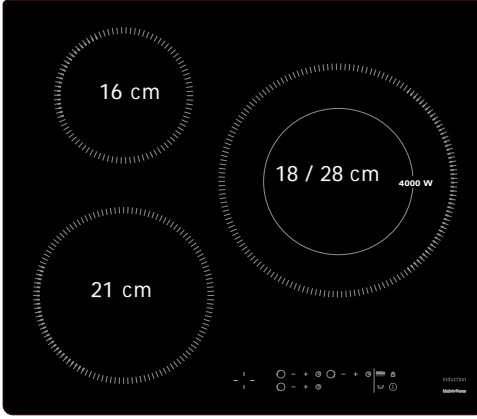



IDENTIFICATION

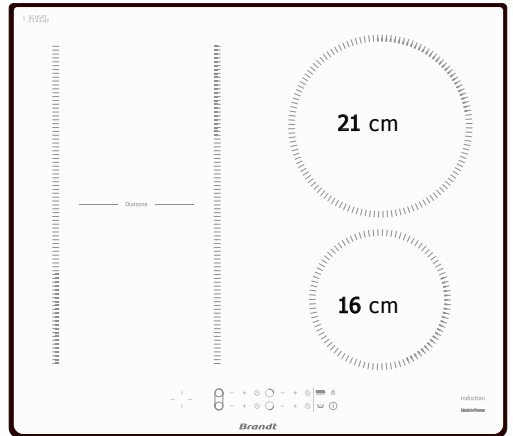
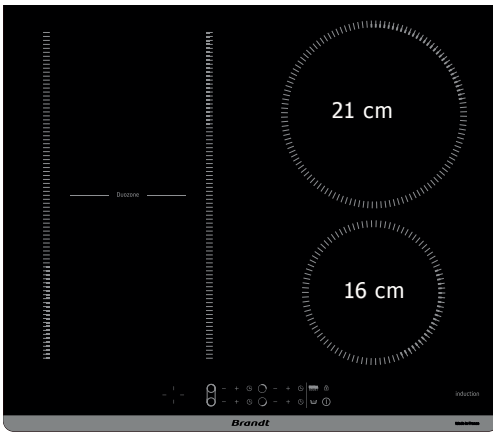
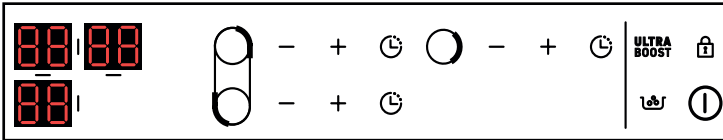
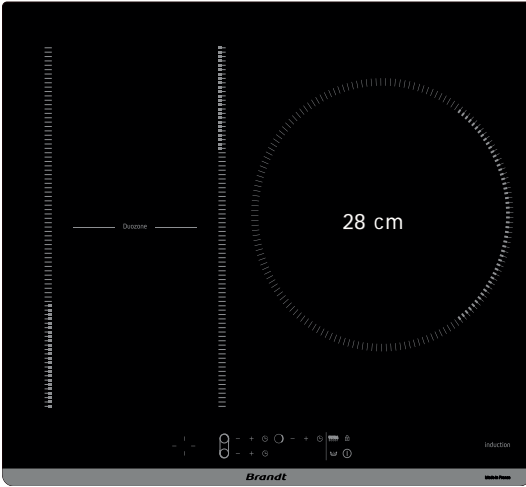



UNPACKING

For future use, remove all protective elements.
 Check and respect the appliance's characteristics that appear on the nameplate.
 Note in the boxes below the service and standard references shown on this plate.

Service :
Type :

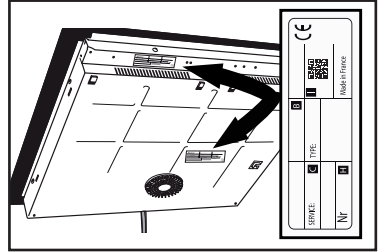

ENCLOSURE

Check that the air intake and outlet are free of obstruction. Comply with the information concerning the fitting dimensions (in millimetres) of the work top destined to receive the hob. Check that air circulates correctly between the front and the back of your hob.

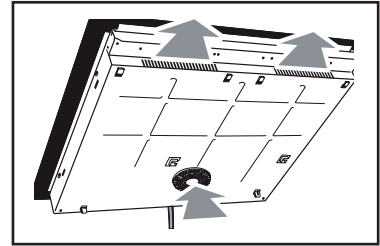

<p>A</p>	<p>B</p>
<p>C</p>	<p>D</p>



INSTALLATION

If you are installing the hob above a drawer,



or above a built-in oven, comply with the dimensions provided on the illustrations to ensure a sufficient air outlet at the front.

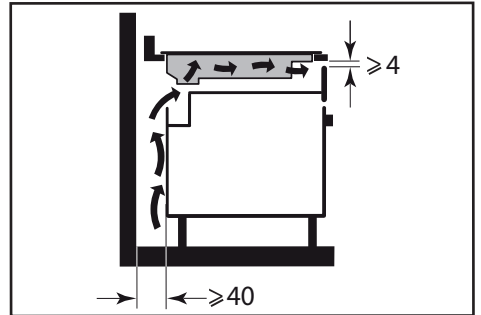

Carefully glue the sealing joint to the entire surround of the glass hob

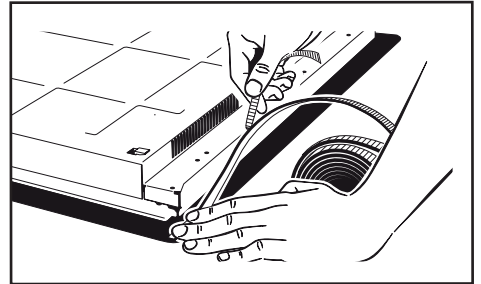

insert the table into the cabinet

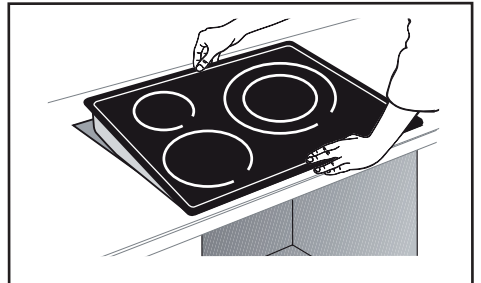



Important

If your hob is located above your oven, the hob's thermal safety devices can impede the simultaneous use of the hob and the oven's pyrolysis programme, display code "F7" in the control zones. In such circumstances we recommend that you increase the hob's ventilation by creating an opening in the side of the cabinet (8 x 5 cm).

Electric connections

These hobs must be connected to the power grid via an all-pole cut-off device that complies with installation regulations in effect. A disconnection device must be incorporated into the fixed wiring.

Identify the type of cable of your hob according to the number of wires and colours.

When switching your hob on or after a lengthy power cut, a code is shown on the control pad (this display is reserved for your after-sales service, where applicable. The user of the hob does not need to take notice of it).

This information disappears after around 30 seconds.

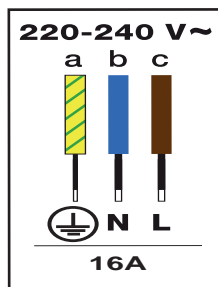
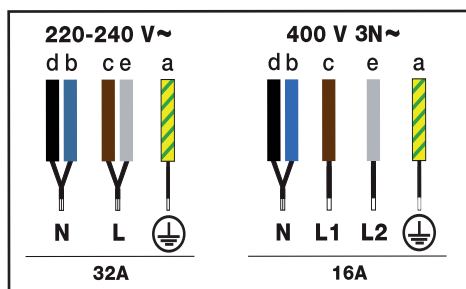



CHOICE OF COOKWARE

Most cookware is compatible with induction. Only glass, earthenware, aluminium without a special bottom, copper and some non-magnetic stainless steel do not work with induction cooking.



We suggest that you choose cookware with a thick and flat bottom. The heat will be distributed better and cooking will be more uniform.

Advice on how to save energy

Cooking with the correctly sized lid saves energy. If you use a glass lid, you can control

BURNER SELECTION

Select the burner which is the right size for the bottom of your cookware (see table). If the base or the cookware is too small, the power indicator will start to flash and the burner will not work, even if the cookware's material is recommended for induction.

Do not use containers with a smaller diameter than that of the fireplace (see table).

Diameter of burner (cm)	Maximum power of burner (Watts)	Diameter of bottom of cookware
16	2500	10 - 18
18	3600	11 - 22
21	3600	12 - 24
28	4000	15 - 32
Duozone	4000	Oval, fishmonger
18 / 28 (3600)	3600	15 - 32
18 / 28 (4000)	4000	15 - 32



When using the two hobs simultaneously, the hob manages the power distribution so as not to exceed the total power of the hob.

When using the maximum power (Ultra Boost) on several hobs at the same time, make sure that you use the best position for your containers according to the model of your hob as shown in the illustrations.

This will avoid automatic power limitation on one of the hobs if the positioning is not optimal:

- ☑ = Recommended positioning
- ☒ = positioning to be avoided

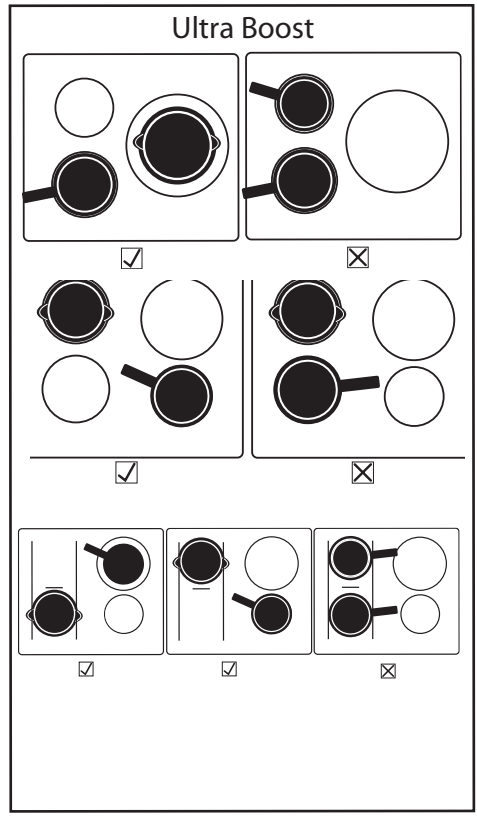



Ⓜ SWITCHING ON - STOPPING

Switching on:

Press the Ⓜ button and then the Ⓜ button corresponding to the desired zone.

A 0 is displayed and a beep indicates that the zone is on. You can set the desired power of the selected cooking zone. If no power is requested, the cooking zone will be switched off automatically.

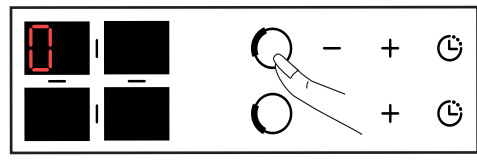
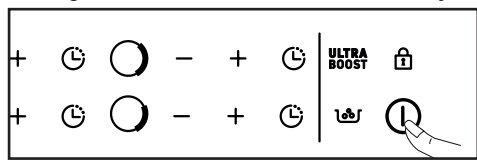

Stopping a zone:

Press and hold the Ⓜ button for the desired heat source.

A long beep sounds and the display goes out or the "H" symbol (residual heat) appears.

General shutdown:

Press and hold the Ⓜ on/off button. A long beep sounds and the display goes out or the symbol "H" (residual heat) appears.

+ / - Power setting

With a power level > 5, a quick double press on the + button allows you to switch directly to power level 9.

Press the + or - button to set the power level from 1 to 9.

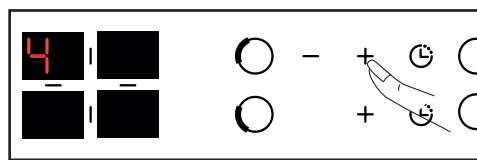

With a power < 5, a quick double press on the + button allows direct access to power 5.

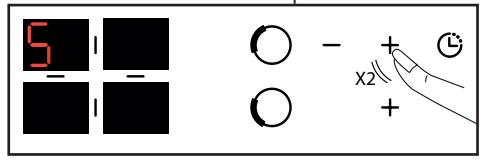

With a power > 5, a quick double press on the + button allows direct access to power 9.

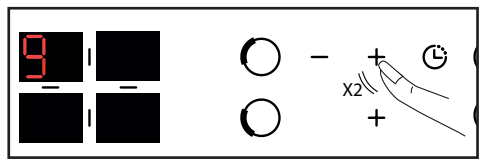

UPress **ULTRA BOOST** to access the maximum power.

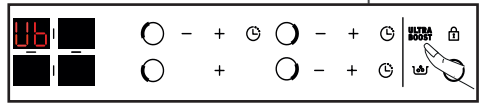

DUOZONE :

Pressing the 2 keys Ⓜ and Ⓜ simultaneously activates the "duoZone" function.

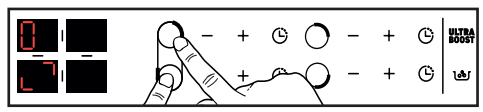

The symbol is displayed. The power and timer settings are made on the controls of the left rear firebox, as for a normal firebox. The setting for the front left firebox is inactive.

To deactivate the "duozone" function, press the Ⓜ or key Ⓜ.



SETTING THE TIMER

Each cooking zone has a dedicated timer that can be set for up to 99 minutes. The timer is incremented from 1 to 15 and then from 5 to 99 and can be started as soon as the relevant cooking zone is in operation.

Press the button of the selected focus a light point is displayed on the right.

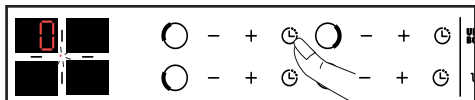

(according to model).

The setting is made by pressing + or - . The 99 minutes can be accessed directly by pressing the - key from the start.

At the end of the cooking time, the display shows 0 and a beep sounds for about 20 seconds. To deactivate the timer, press any of the control keys of the relevant cooking zone.

To stop the timer manually, press and hold the + and - keys simultaneously or return to 0 with the - key. Press to view the remaining time.

Boil function

This function allows you to boil and maintain the boiling of water for cooking pasta for example.

Select your cooker, press the "Boil" button briefly

By default, the quantity of water proposed is 2 litres but you can modify it using the + or - keys. Set the desired amount of water (from 1 to 6 litres).

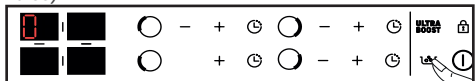

Confirm by pressing the "Boil" symbol or wait a few seconds and the confirmation will be automatic.

The cooking process starts: b fixed + o scrolling in the display.

A beep will sound when the water is boiling and

"B" + "o" will flash in the display.

Pour in the pasta and confirm by pressing the "Boil" button .

By default the display suggests power 8 and a cooking time of 8 minutes.

However, you can adjust the proposed power and cooking time.

A beep will sound at the end of the cooking time.

NOTE: It is important that the water is at room temperature when you start cooking. Do not use a cast iron pan for this function.

You can also use this function to cook any food that needs to be cooked in boiling water.

CHILD SAFETY

Your hob has a child lock which locks the controls when the appliance is switched off or during cooking. For safety reasons, however, the button remains active and allows the heating zones to be switched off even when locked.

Locking :

Press the button until the lock symbol appears and a beep confirms your operation

The display of the operating cooking zones now shows the power and the lock symbol alternately.

The display of the operating cooking zones now shows the power and the lock symbol alternately.

Unlocking :





Press the button until the symbol disappears and a beep confirms your operation.





CLEAN LOCK function:

The Clean Lock function allows the table to be temporarily locked during cleaning.

To activate the Clean Lock function, press the  button briefly, a beep will sound and the  symbol will flash. After about 1 minute, the lock is automatically deactivated. A double beep is heard and the  symbol disappears. You can deactivate the Clean Lock function at any time by pressing and holding the  button.

SAFETY PRECAUTIONS AND RECOMMENDATIONS

Residual heat:

After intensive use, the cooking zone that you have just used can remain hot for several minutes.

The symbol **H** is displayed during this period.

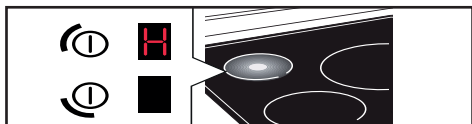

Avoid touching the areas concerned during this time.

Anti-overheat protection:

Each cooking zone has a safety sensor that constantly monitors the temperature of the bottom of the cookware. In the event that empty cookware is left on a cooking zone that is switched on, the hob automatically lowers the power output and thus limits any risk of damage.

Protection against overflows

A special display (symbol ), a sound signal, followed with the hob switching off, may be triggered in the following cases:

- Overflow that spills onto the buttons
- Damp towel placed over the buttons.
- Metallic object placed on the buttons

Remove the object or clean and dry the touch controls, then restart cooking.



Auto-Stop :

Your hob has an auto-stop device, which automatically stops any cooking zone which remains switched on for an excessive length of time (between 1 and 10 hours depending on the power used).

If this safety system is triggered, the cut-off to the cooking zone is shown with the **"AS"** display on the control panel and a beep sounds for about 2 minutes. Simply press any of the buttons to stop this.



Tips

Sounds which are similar to those of a clock mechanism may be given off.

These noises occur when the hob is working. They disappear or reduce depending on the heating configuration. There may also be whistling sounds depending on the model and quality of your cookware. The noises described are normal. They are related to induction technology and do not indicate a problem.



Tips

We do not recommend a protective device.



For light dirt, use a disinfectant sponge. Thoroughly moisten the zone to be cleaned with hot water, then wipe off.

For a build-up of baked-on dirt or sweet overflows, use a disinfectant sponge and/or a special glass scraper. Thoroughly moisten the zone to be cleaned with hot water. Use a scraper for glass to remove the large bits, finish off with a disinfectant sponge, and then wipe off.

For rings and hard water residue, apply warm white vinegar to the stain, leave on, then wipe with a soft cloth.

For shiny metal streaks or weekly maintenance, use a special vitroceramic glass product.

Important note: do not use any powders or abrasive sponges. Use creams and special delicate glassware sponges.



DURING INITIAL USE:

- **An indicator light appears.** This is normal. It will go away after 30 seconds.
- **Your installation blows a fuse or one side only of the hob works.** The electrical connection of your hob is incorrect. Check its compliance.
- **The hob smells the first few times it is used for cooking.** The appliance is new. Heat up each ring for half an hour with a saucepan full of water.

6.2 WHEN POWERING ON:

The hob does not work and the indicator lights on the control panel are not on.

The appliance is not receiving electricity. The electrical supply is defective or the connection is incorrect. Inspect the electrical circuit breaker and fuses.

- **The hob does not work and another message is displayed.** The electronic board is functioning poorly. Call the After-Sales Service Department.
- **The hob does not work,** the symbol  is displayed. Unlock the child safety device.
- **Error code F9:** voltage less than 170 V
- **Error code F0:** voltage less than 5°C

6.3 DURING USE:

- **The hob has stopped working. The symbol  is displayed and there is a sound signal.**

There was an overflow or an object is in contact with the control panel. Clean or remove the object, then begin cooking again.

- **Code F7 is displayed.**
The electronic circuits have overheated. Check the hob's ventilation.
- **During operation of a heating zone, the keypad display continues to flash.**
The cookware used is not compatible with induction or its size is not suitable for the burner.
- **The cookware makes noise and your hob clicks during cooking** (see chapter on Safety precautions and recommendations 4.5).
This is normal with some types of cookware. This is caused by the transfer of energy from the hob

to the cookware.

- **The fan continues to function after your hob is turned off.**
This is normal. It cools the electronic parts.
- **In the event of persistent malfunction.**
Switch off your hob for 1 minute. If the problem persists, contact the after-sales service.



ENERGY EFFICIENCY



- IT** Informazioni relative ai piani cottura elettrici per uso domestico - UE n° 66/2014
- NL** Informatie met betrekking tot huisvuiltoestellen elektrische kooplampen - UE n° 66/2014
- PL** Informacje dotyczące domowych płyt grzewczych elektrycznych - UE n° 66/2014
- PT** Informações relativas a placas eiras domésticas - UE n° 66/2014
- SK** Informácia v prípade elektrických varných desek pre domácnosť - UE n° 66/2014
- SV** Information om elektriska hällar för hushållsbruk - UE n° 66/2014

- FR** Informations concernant les plaques de cuisson domestiques électriques - UE n° 66/2014
- CS** Informace týkající se elektrických varných desek pro domácnost - UE n° 66/2014
- DA** Oplysninger for elektriske planer til husholdningsbrug - UE n° 66/2014
- DE** Informationen zur elektrischen Haushaltsbackwaren - UE n° 66/2014
- EL** Πληροφορίες για οικιακές ηλεκτρικές εφές - UE n° 66/2014
- EN** Information for domestic electric hobs - UE n° 66/2014
- ES** Información sobre las placas de cocina domésticas eléctricas - UE n° 66/2014

Symbol	Value	LKCXXXX		LKWXXXX		LKYXXXX	
Model identification							
Rating plate							
Type of hob		<p> FR Induction C5; Induction DA; Induction DE; Electromagnetic EN; Induction EL; Induction ES; Induction FR; Induction GR; Induction HU; Induction IT; Induction PT; Induction SK; Induction SV FR Induction C5; Induction DA; Induction DE; Electromagnetic EN; Induction EL; Induction ES; Induction FR; Induction GR; Induction HU; Induction IT; Induction PT; Induction SK; Induction SV </p>					
Total power		7400	7400	7400	7400	7400	3
Number of cooking zones and/or areas		3	4	4	4	4	3
Heating technology (inductive cooking zones and cooking area within cooking zones) (heat pump)		Induction **					
For heater cooking zones or areas: overall cooking area per electric heated cooking zone, rounded to the nearest 5 mm	1	φ	21	18	16	15	28
	2	φ	16	18	21		
	3	φ	29	16			
	4	φ		21			
	5	φ					
For non-ducted cooking zones or areas: length and width of useful surface area per electric heated cooking zone, rounded to the nearest 5 mm	6	LxW				37x18	37x18
	7	LxW					
Energy consumption for the hob calculated per kg	1	EC _{min,cooktop}	170,2	188,2	175,1	172,8	
	2	EC _{max,cooktop}			178,1	170,2	
	3	EC _{norm,cooktop}	172,5	175,1			
	4	EC _{multicooktop}	170,2				
	5	EC _{total,cooktop}					
	6	EC _{min,cooktop}				178,7	
	7	EC _{max,cooktop}					



Interventions

Any work on your appliance must be carried out by a qualified professional who is a brand owner. When you call, in order to make it easier to deal with your request, please have the complete references of your appliance (commercial reference, service reference, serial number). This information can be found on the nameplate attached to the bottom of the appliance.

ORIGINAL PARTS

When servicing, only use certified original spare parts.

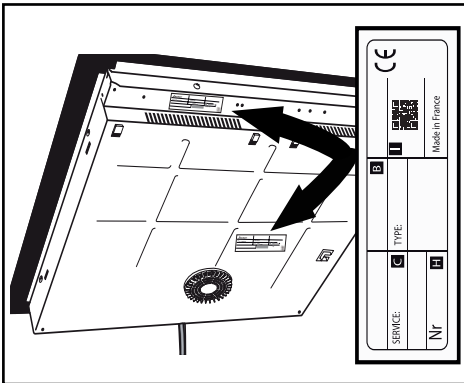

B: Commercial reference

C: Service reference

H: Serial number

I: QR Code