

FR

CS

DA

DE

EL

EN

ES

FI

IT

NL

NO

PL

PT

SK

SV

Brandt



USER INSTRUCTIONS EN

OVEN

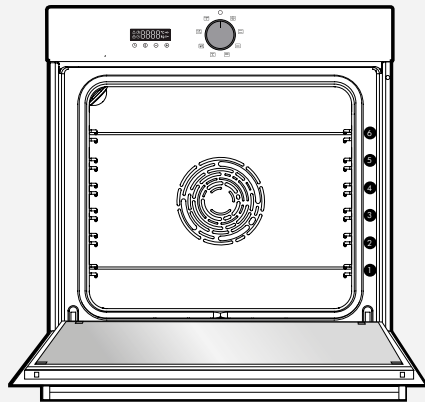

Dear Customer,

You have just acquired a **BRANDT** product and we would like to thank you.

We have designed and made this product with you, your lifestyle and your requirements in mind so that it meets your expectations. We have devoted our know-how, our innovative spirit and the passion that has been guiding us for over 60 years.

In an effort to ensure that our products meet your requirements in the best possible way, our Customer Relations department is at your disposal, to answer all your questions and to listen to all your suggestions.

Visit our website www.brandt.com where you will find our latest innovations, as well as useful and complementary information.

BRANDT is delighted to assist you every day and hopes you get the most out of your purchase.

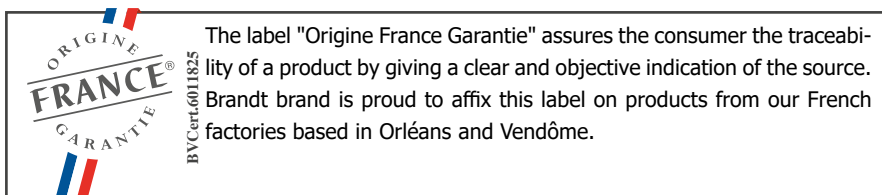

<https://brandt.com/>



Important: Before using your appliance, read this user guide carefully to familiarise yourself more quickly with its operation.



Table of Contents

SAFETY INSTRUCTIONS	4
ENVIRONMENT	6
Environment	6
Energy saving councils	6
INSTALLATION	7
Choice of location and fitting	7
Electrical connection.....	8
DESCRIPTION OF THE OVEN	9
Presentation of the oven	9
Display and buttons	9
Accessories.....	10
HOW TO USE YOUR APPLIANCE	12
Setting	12
Setting menu	12
Cooking mode.....	14
Starting cooking.....	15
CLEANING	17
Cleaning inside - outside	18
ANOMALIES AND SOLUTIONS	20
SERVICE CALLS	21
Service calls.....	21
COOKING AID	21
Cooking tables.....	22
Recipes with yeast	24
Performance testing.....	25
Automatic combined steam functions	26



IMPORTANT - READ CAREFULLY AND RETAIN FOR FUTURE USE.

This user guide is available for download on the brand's web-site.

When you receive the appliance, unpack it or have it unpacked immediately. Check its general appearance. Make a note of any reservations on the delivery slip and keep a copy.



Important:

This appliance may be used by children aged 8 years and older, and by persons with impaired physical sensorial or mental capacities, or without experience or knowledge, if they are supervised or have received prior instructions on how to use the appliance safely and have understood the risks involved. Children must not be allowed to play with the appliance. Cleaning and maintenance operations must not be carried out by children without supervision.

— Children must be supervised to prevent them from playing with the appliance.



WARNING:

— The appliance and its accessible parts become hot during use. Be

careful not to touch the heating elements inside the oven. Children under 8 years old must not be allowed near it unless they are supervised at all times.

— This appliance is designed to cook with the door closed.

— Before pyrolytic cleaning of your oven, remove all accessories and any thick deposits.

— During cleaning, the surfaces may become warmer than under normal conditions of use. It is advisable to keep children away from the appliance.

— Do not use a steam cleaner.

— Do not use abrasive cleaning products or hard metal scrapers for cleaning the oven's glass door, as they could scratch the surface and cause the glass to shatter.



WARNING :

Make sure the appliance is disconnected from the power before replacing the lamp in order to avoid the risk of electric shock. Change the lamp only when the appliance has cooled down. To unscrew the view port and the light, use a rubber glove, which will make disassembly easier.



The electrical plug must remain accessible after installation.

— It must be possible to disconnect the appliance from the power supply, either using a plug or by fitting a switch on the fixed wiring system in accordance with installation rules.

— If the power cable is damaged, it should be replaced by the manufacturer, its after-sales service department or by a similarly qualified person in order to avoid danger.

— This appliance may be installed either under a worktop or in a cabinet column, as indicated on the installation diagram.

— Centre the oven in the unit so as to ensure a minimum distance of 10 mm between the appliance and the surrounding unit. The material of the unit supporting the appliance must be heat-resistant (or covered with a heat-resistant material). For greater stability, attach the oven to the unit with 2 screws through the holes provided on the side panels.

— In order to avoid overheating, the appliance must not be installed behind a decorative door..

— This appliance is designed to be used for domestic and similar

applications such as:

Kitchen areas for the staff of shops, offices and other professional premises; Farms; Use by clients of hotels, motels and other residential type establishments; guest house type environments.

— The oven must be turned off when cleaning inside the oven.

Do not modify the characteristics of this appliance; doing so could be dangerous.

Do not use your oven as a larder or to store any items after use.



CARE FOR THE ENVIRONMENT

- This appliance's packing materials are recyclable. Please recycle them and help protect the environment by depositing them in municipal containers provided for this purpose.

- Your appliance also contains many recyclable materials. It is therefore marked with this logo to indicate that used appliances must not be mixed with other waste.

The appliance recycling organised by your manufacturer will therefore be conducted in optimum conditions, in accordance with European directive 2002/96/EC on electrical and electronic equipment waste.

Consult your local authority or your retailer to locate your nearest used appliance drop-off points.

- We thank you for your help in protecting the environment.

ENERGY SAVING COUNCIL

Keep the oven door closed during baking.



CHOICE OF LOCATION AND FITTING

The diagrams show the dimensions of a cabinet that will be able to hold your oven.

This appliance may be installed either under a worktop (A) or in a column (B). If the cabinet is open, its opening at the back must be 70 mm maximum.

Install the oven in the furniture. To do this, remove the rubber stops and pre-drill a 2-mm diameter hole in the wall of the furniture to avoid splitting the wood. Attach the oven with the two screws. Re-position the rubber stops.



Tip

To be certain that you have properly installed your appliance, do not hesitate to call on a household appliance specialist.



Warning :

If the electrical installation in your residence requires any changes in order to hook up your appliance, contact a professional electrician. If the oven malfunctions in any way, unplug the appliance or remove the fuse corresponding to the sector where the oven is hooked up.

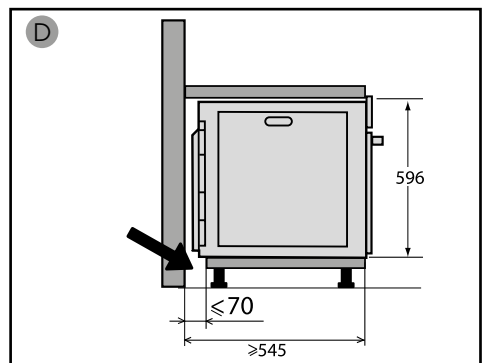
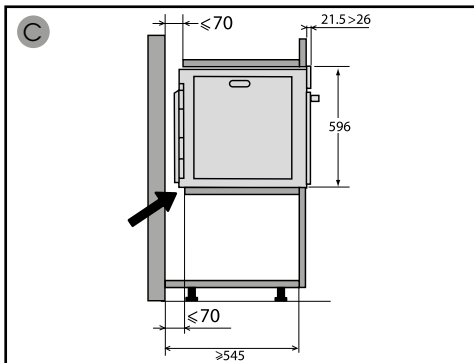
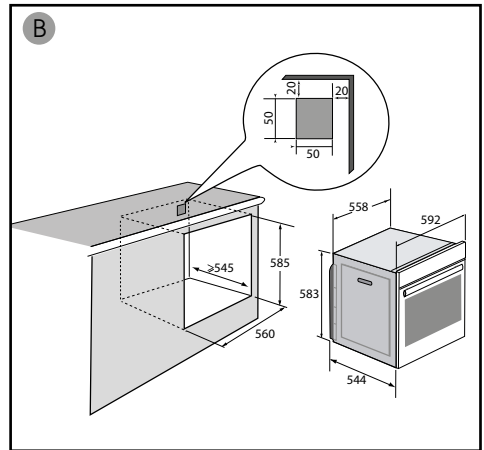
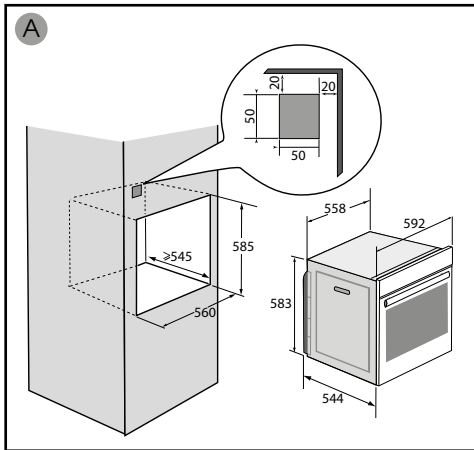



ELECTRICAL CONNECTION

Your oven must be connected with a (standard) power cable with 3 conductors of 1.5mm² (1 live + 1 neutral + earth) which must be connected to a 220-240V_~ single-phase grid by means of a 1 live + 1 neutral + earth CEI 60083 standard power socket or via an all-poles cut-off device in compliance with the installation rules.

Warning

The safety wire (green-yellow) is connected to the appliance's terminal and must be connected to the earth terminal of the electrical set-up.

The fuse in your set-up must be 16 amperes.

We cannot be held responsible for any accident resulting from inexistent, defective or incorrect earthing.

• **Prior to first use**

Before using your oven for the first time, heat it with the door closed for about 15 minutes on the highest temperature. to break in the appliance. The mineral wool surrounding the oven cavity may initially give off a particular odour due to its composition. You may also notice smoke development. This is normal.

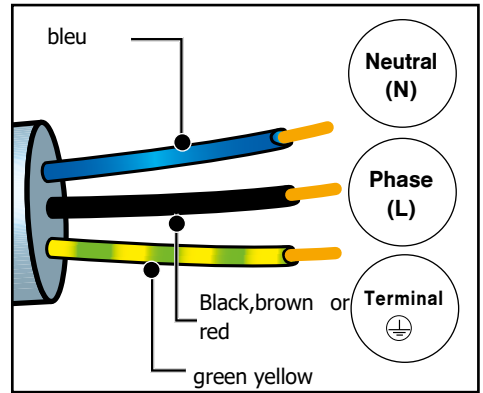



Description of the oven

PRESENTATION OF THE OVEN

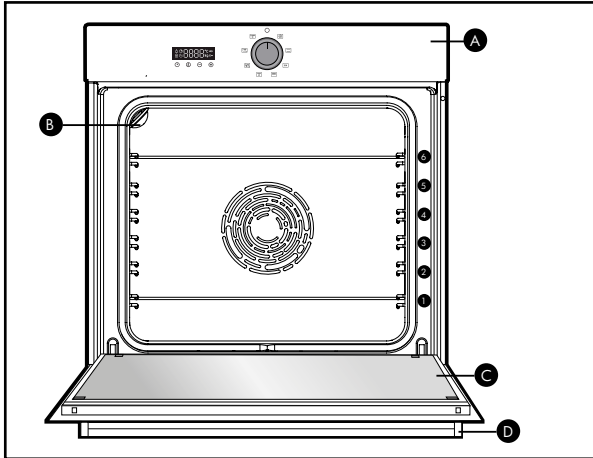

- A** Control panel
- B** Light
- C** Door
- D** Handle

This oven has 6 positions for the accessories: shelf supports 1 to 6.

DISPLAY AND BUTTONS

• Display



- Cooking time
- End of cooking
- Keypad lock
- Timer
- Temperature indicator
- Pre-heating indicator
- Door lock

• Buttons

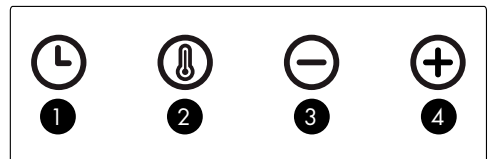

- 1** Set clock and cooking time
- 2** Set temperature
- 3** - button
- 4** + button



ACCESSORIES

• Anti-tip safety grid

The grid can be used to hold all dishes and moulds containing foodstuffs to be cooked or browned. It can be used for barbecues (to be placed directly on the grid).

Insert the anti-tip safety grid towards the back of the oven.

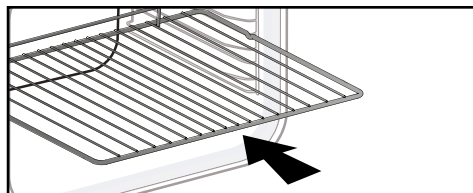

• Multi-purpose 45mm drip pan

When inserted in the supports under the grid with the handle towards the oven door, it collects juice and fat from grilling, and can be used half-filled with water as a double-boiler.

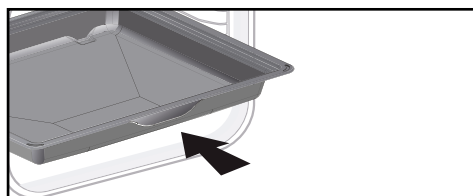

• 20mm pastry dish

When inserted in the supports with the handle towards the oven door, it is ideal for baking cookies, shortbread and cupcakes. Its tilted surface makes it practical and easy to use. Can also be inserted into the supports under the grid to collect juice and fat from grilling.

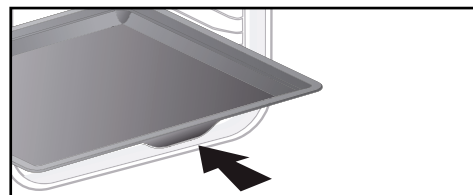

Tip
To avoid fumes when cooking fatty meats, we recommend you add a small amount of water or oil to the bottom of the drip pan.



Warning :
Under the effect of heat, the accessories may become deformed without affecting their function. They will return to their original shape when cooled.



Description of the oven



How to use your appliance

SETTING

• Setting the clock

When switching on the display flashes at 12:00.

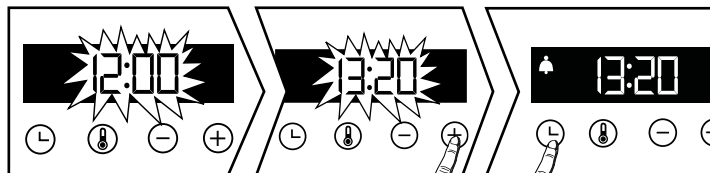

When switching on the display flashes at 12:00. Set the clock with + or -. Confirm with . If there is a power cut, the clock flashes

• Changing the clock

The function selector switch must be in the 0 position.

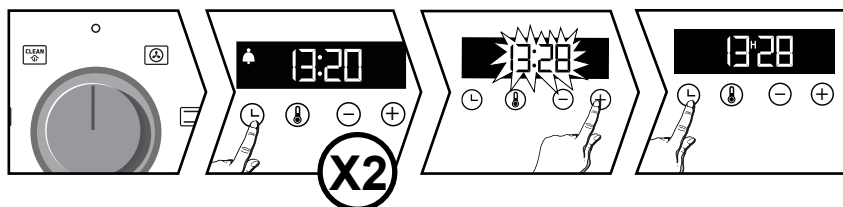

Press . The symbol appears. Press again adjust the clock setting with + or - . Confirm with . The cooking end time is automatically saved after a few seconds.

• Timer

This function can only be used when the oven is switched off.

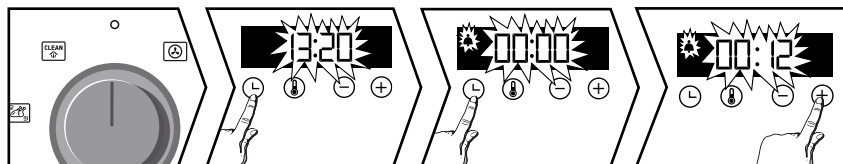

Press . The timer flashes. Set the timer with + or -. Press to confirm. The timer will then start. Once the time has lapsed, there is a sound signal. To stop it, press any key. The time appears again in the display.



NB: You can modify or cancel the timer at any time. To cancel, go back to the timer menu and set to 00:00. Without having to confirm, the adjustment is automatically saved after a few seconds.

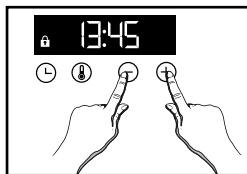

How to use your appliance

• Keypad locking





Press + and - at the same time until the  symbol appears on the screen. To unlock the keypad, press + and - together until the  symbol disappears off the screen.

SETTING

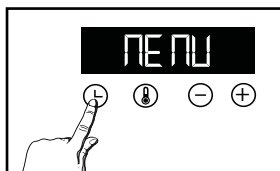
You can adjust different settings on your oven. To do so: Press  until you get to the "MENU" display to access the settings mode.



Press  again to scroll through the different settings. Activate or de-activate the different parameters with + and -; see table below:

	Activate/de-activate the beeping sound of the buttons
	Activate/de-activate demonstration mode

To exit the "MENU", press .



How to use your appliance

COOKING MODES

MANUAL FUNCTIONS :



CIRCULATING HEAT*

Min temperature 35°C, max 235°C

Recommended for keeping white meat, fish and vegetables moist. For cooking multiple items on up to three levels.



TRADITIONAL

Min temperature 35°C, max 275°C

Recommended for slow, gentle cooking: rich game, etc. For retaining the juices in red meat roasts. For simmering in a covered casserole, dishes that were begun on the hob (coq au vin, stew).



ECO*

Min temperature 35°C, max 250°C

This setting saves energy while maintaining the quality of the cooking.

All types of cooking are done without preheating.



FULL GRILL

Min temperature 180°C, max 275°C

Recommended for toast, gratin dishes, browning crème brûlée, etc.



GRILL PULSE

Min temperature 100°C, max 230°C

Roasts and poultry are juicy and crisp all over.

Slide the drip tray on to the bottom shelf support.

Recommended for all spit-roasted poultry or meat, for sealing and thoroughly cooking a leg or a rib of beef. To retain the moist texture of fish steaks.

AUTOMATIC FUNCTIONS :

Brandt offers you 2 new functions which automatically combine two cooking modes: traditional cooking and steam cooking in order to preserve the nutritional qualities of food and achieve faster cooking.



FISH

Recommended for cooking whole fish or fillets.



POULTRY

Recommended for cooking chickens, turkeys, guinea fowl and ducks.

For these 3 functions, all you need to do is introduce lukewarm water in sufficient quantity into your dish (drip pan) and place it in your oven in the bottom tier and your food to be cooked in tier 3.

For the quantity of water to be introduced into the drip pan, refer to the table of automatic combined functions with steam association at the end of the manual.



"Smart Assist"

Your oven has the "SMART ASSIST" function which, when programming a cooking time, will suggest a cooking time which can be modified depending on the selected cooking mode.

**Cooking mode as per standard EN 60350-1: 2016 to demonstrate compliance with requirements of the energy label of European regulation UE/65/2014.*



How to use your appliance

STARTING COOKING

• Immediate cooking

The programmer must only display the time. It should not be flashing. Turn the function selector to any position.





For manual functions :

The temperature rise starts immediately. Your oven recommends a modifiable temperature. The oven heats up and the temperature indicator flashes. A series of beeps will sound when the oven reaches the programmed temperature.

For automatic functions:

 appears on the screen.

Select your food using the table at the end of the manual. Press the + and - keys until you obtain the desired diagram in the display, then confirm with .

A weight flashes; enter the actual weight of your food with the + and - keys then validate with .

You have nothing else to adjust, the temperature and the cooking time are calculated automatically. The end of cooking time flashes, confirm with . Your cooking starts immediately.



• Changing the temperature

Press .

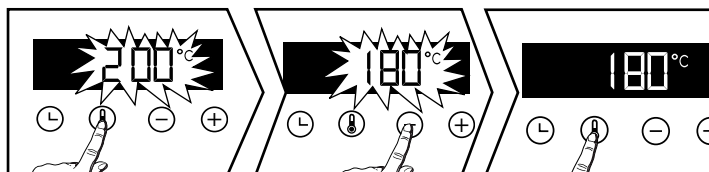
Adjust the temperature with + or -. Confirm by pressing .



• Programming the cooking time

Use the immediate cooking programme, then press , the cooking time flashes  and it is now possible to set it. Press + and - to adjust the cooking time.

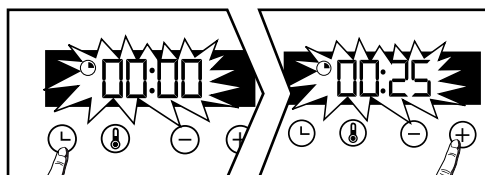



How to use your appliance



"Smart Assist"

Your oven has the "SMART ASSIST" function which, when programming a cooking time, will suggest a cooking time which can be modified depending on the selected cooking mode. See the table opposite:

The cooking time is saved automatically after a few seconds. The time starts to count down as soon as the cooking temperature is reached.

COOKING MODE	TIME
	30 min
	30 min
ECO	30 min
	7 min
	15 min

• Delayed start

Proceed as for programmed cooking. After setting the cooking time, press the cooking end time flashes.

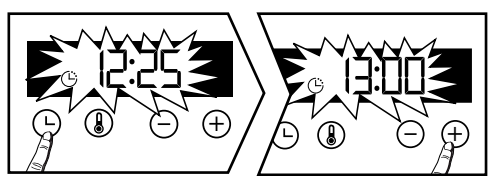

The display flashes. Set the cooking end time with + and - . The cooking end time is automatically saved after a few seconds. The cooking end time display stops flashing.



Cleaning

INTERIOR - EXTERIOR CLEANING

• Steam cleaning of the cavity

Thanks to this function you will spend less time cleaning your oven, with an eco-responsible action. To do this, spray your cavity with 300 ml of water and start the steam cleaning function by positioning the lever in the position  for a period of 35 min.

• Cleaning the outer surfaces

Use a window washing product applied to a soft cloth. Do not use abrasive creams or scouring sponges.

• Cleaning the shelf supports

Lift the front part of the wire shelf support upwards. Press the entire shelf support and release the front hook from its housing. Then gently pull the whole of the support towards you to release the rear hooks from their housing. Pull out the two shelf supports.

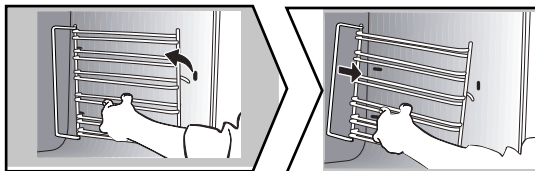

• Cleaning the inside glass



Warning

Do not use scouring cleaning products, abrasive sponges or metal scrapers to clean the oven's class door, which may scratch the surface and lead to the glass breaking.

To clean the inside glass, remove the door. Before doing this, remove any excess grease with a soft cloth and washing up liquid.

• Cleaning the inside glass

Open the door fully and block it with the plastic wedge provided in your appliance's plastic pouch.

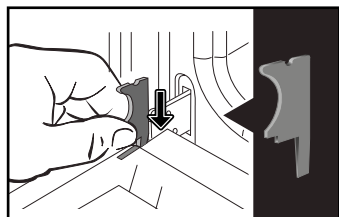

Use a tool (screwdriver) to press the slots  in order to unclip the glass panel. Remove the glass panel.



Important :

Make sure to mark the mounting direction of this first window (shiny side towards you).



Cleaning

Depending on the model, the door consists of two additional glass panels, with a black rubber spacer at each corner. If necessary, remove them to clean.

Do not soak the glass panels in water. Rinse with clean water and dry off with a lint-free cloth.

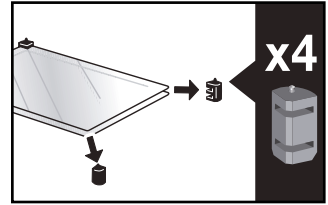
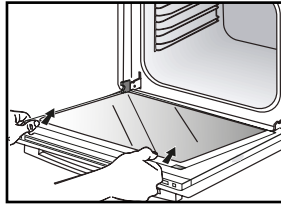
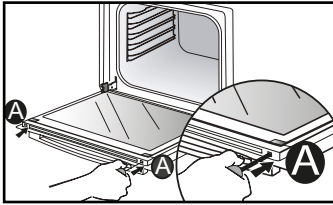

• Re-assembling the door

After cleaning, reposition the four rubber stops with the arrow upwards.

Reposition all of the glass panels.

Slip the last glass panel into the metal stops, then clip it in with the shiny side facing outwards.

Remove the plastic wedge.

Your appliance is now ready for use again.

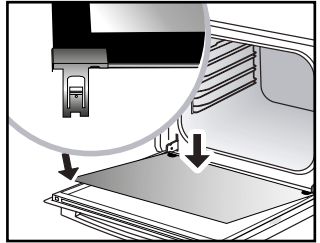
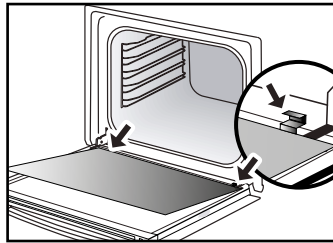
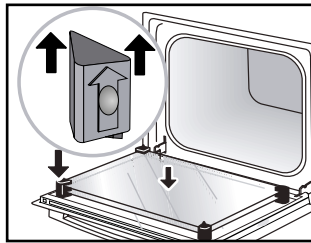

• Replacing the oven lamp



Warning:

Make sure the appliance is disconnected from the power before replacing the lamp in order to avoid the risk of electric shock. Change the lamp only when the appliance has cooled down.

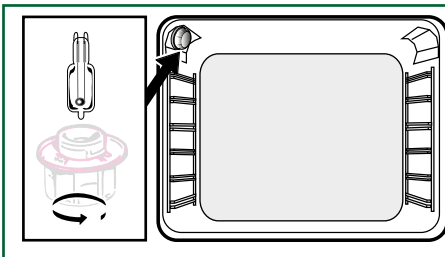

Bulb specification:

25 W, 220-240 V~, 300°C, G9 cap.

To unscrew the view port and the light, use a rubber glove, which will make disassembly easier.



ANOMALIES AND SOLUTIONS

The oven is not heating. Check that the oven is correctly connected and that your installation's fuse is not out of service. Increase the selected temperature.

The oven light is not working. Replace the bulb or the fuse. Check that the oven is correctly connected.

The cooling fan continues to operate after the oven stops. This is normal; the fan may continue running until a maximum of 1 hour after cooking to lower the temperature inside and outside the oven. If the fan runs for over an hour, contact the After Sales Department.

The symbol  flashes in the display.

Door locking fault; contact the Customer Services Department.

Vibration noise.

Check that the power cord is not in contact with the rear wall.

This does not affect the proper operation of your unit, but may generate vibration noise during ventilation. Remove your unit and move the cord. Replace your oven.



SERVICE CALLS

Any repairs made to your appliance must be carried out by a qualified professional authorised to work on the brand. When calling, please provide the complete references of your appliance (commercial reference, service reference, serial number), so that we can handle your call better. This information appears on the manufacturer's nameplate attached to your equipment.

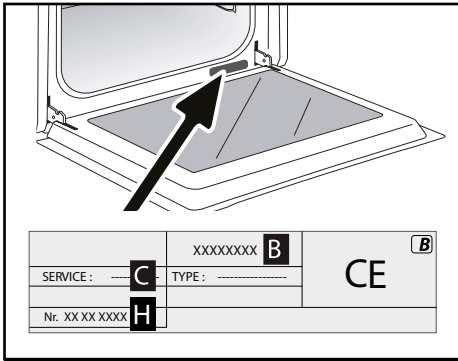

- B: Commercial reference
- C: Service reference
- H: Serial number

GENUINE REPLACEMENT PARTS

During maintenance work, request that only certified genuine replacement parts are used.





DISHES															min	
Pastries																
Madeleines	220	3						200	3							5-10
Choux pastry	200	3					180	3						180	3	30-40
Flaky pastry hors d'oeuvres	220	3					200	3								5-10
Savarin cake	180	3												175	3	30-35
Shortcrust tart	200	1					195	1								30-40
Thin flaky crust tart	215	1					200	1								20-25
Tart made with yeast-based pastry	210	1					200	1								10-30
Other																
Skewers	220	3			210	4										10-15
Terrine pâté	200	2					190	2								80-100
Shortcrust pizza	200	2														30-40
Dough-based pizza																15-18
Quiches																35-40
Soufflé													180	2		50
Pies	200	2														40-45
Bread	220						200	220								30-40

* Depending on the model

All T°C and cooking times are given for pre-heated ovens.

N.B: Before being placed in the oven , all meat must remain at least 1 hour at room temperature.

RELATIONSHIP OF SETTINGS TO TEMPERATURE T °F / °C									
Setting	1	2	3	4	5	6	7	8	9 maxi
° Fahrenheit	85	140	195	250	300	355	410	465	525



DISHES															min
Meat															
Roast pork (1kg)	200	2						180	2						60
Roast veal (1kg)	200	2					180	2							60-70
Roast beef	240	2													30-40
Lamb (leg, shoulder, 2.5kg)	220	1			220					200	2				60
Poultry (1kg)	200	2			220		180	2		210	3				60
Large pieces of poultry	180	1													60-90
Chicken thighs					220	3				210	3				20-30
Pork/veal chops					210	3									20-30
Beef ribs (1kg)					210	3				210	3				20-30
Lamb chops					210	3									20-30
Fish															
Grilled fish					275	4									15-20
Cooked fish (bream)	200	3					180	3							30-35
Fish in papillotte	220	3					200	3							15-20
Vegetables															
Gratins (cooked foods)					275	2									30
Potato gratin	200	2					180	2							45
Lasagne	200	3					180	3							45
Stuffed tomatoes	170	3					160	2							30
Pastries															
Sponge cake			180	2									180	2	35
Swiss roll	220	3											180	2	5-10
Buns	180	1	210										180	2	35-45
Brownies	180	2					175	3							20-25
Cake - Pound cake	180	1	180	1									180	2	45-50
Clafoutis	200	2					180	3							30-35
Baked custards	165	2											150	2	30-40
Cookies - Shortbread	175	3													15-20

* Depending on the model



Recipe with yeast (depending on model)

Ingredients:

● Flour 2 kg ● Water 1240 ml ● Salt 40 g ● 4 packets of dehydrated baker's yeast

Mix the dough in a mixer and allow to rise in the oven.

Method: For yeast-based pastry recipes. Pour the dough into a heat-resistant dish. Remove the wire shelf supports and put the dish on the bottom.

Pre-heat the oven to 40–50°C with the circulating heat function for five minutes. Stop the oven and allow the dough to rise for 25-30 minutes thanks to the residual heat.





PERFORMANCE TESTING ACCORDING TO STANDARD CEI 60350











FOOD	* Cooking modes	SHELF	ACCESSORIES	°C	TIME min.	PREHEAT
Shortbread (8.4.1)		5	Deep Tray 45mn	150	30-40	yes
Shortbread (8.4.1)		5	Deep Tray 45mn	150	25-35	yes
Shortbread (8.4.1)		2 + 5	Deep Tray 45mn + grill	150	25-45	yes
Shortbread (8.4.1)		3	Deep Tray 45mn	175	25-35	yes
Shortbread (8.4.1)		s	Deep Tray 45mn + grill	160	30-40	yes
Small cakes (8.4.2)		5	Deep Tray 45mn	170	25-35	yes
Small cakes (8.4.2)		5	Deep Tray 45mn	170	25-35	yes
Small cakes (8.4.2)		2 + 5	Deep Tray 45mn + grill	170	20-40	yes
Small cakes (8.4.2)		3	Deep Tray 45mn	170	25-35	yes
Small cakes (8.4.2)		2 + 5	Deep Tray 45mn + grill	170	25-35	yes
Fatless sponge cake (8.5.1)		4	Grill	150	30-40	yes
Fatless sponge cake (8.5.1)		4	Grill	150	30-40	yes
Fatless sponge cake (8.5.1)		2 + 5	Deep Tray 45mn + grill	150	30-40	yes
Fatless sponge cake (8.5.1)		3	Grill	150	30-40	yes
Fatless sponge cake (8.5.1)		2 + 5	Deep Tray 45mn + grill	150	30-40	yes
Apple pie (8.5.2)		1	Grill	170	90-120	yes
Apple pie (8.5.2)		1	Grill	170	90-120	yes
Apple pie (8.5.2)		3	Grill	180	90-120	yes
Surface browning (9.2.2)		5	Grill	275	3-6	yes

*Depending on the model

N.B. : To cook on 2 levels, dishes can be taken out at different times.



TABLE OF COMBINED FUNCTIONS AUTOMATIC WITH VAPOR ASSOCIATION

Position of the function	Display in programmer	Food	Amount of water to add
		Chicken	500 ml lukewarm water in the multipurpose tray
		Duck	500 ml lukewarm water in the multipurpose tray
		Turkey	500 ml lukewarm water in the multipurpose tray
		Pintade	800 ml lukewarm water in the multipurpose tray
		Whole fish (large)	500 ml lukewarm water in the multipurpose tray
		Whole fish (flat)	300 ml lukewarm water in the multipurpose tray
		Small whole fish	300 ml lukewarm water in the multipurpose tray
		Fish fillets	300 ml lukewarm water in the multipurpose tray

IMPORTANT

Insert the multipurpose tray (with lukewarm water) in the lower shelf, level 1 and your food to be cooked in the shelf level 3.

